

QUANTUM CABO

CSP50PTS & CSP60PTS

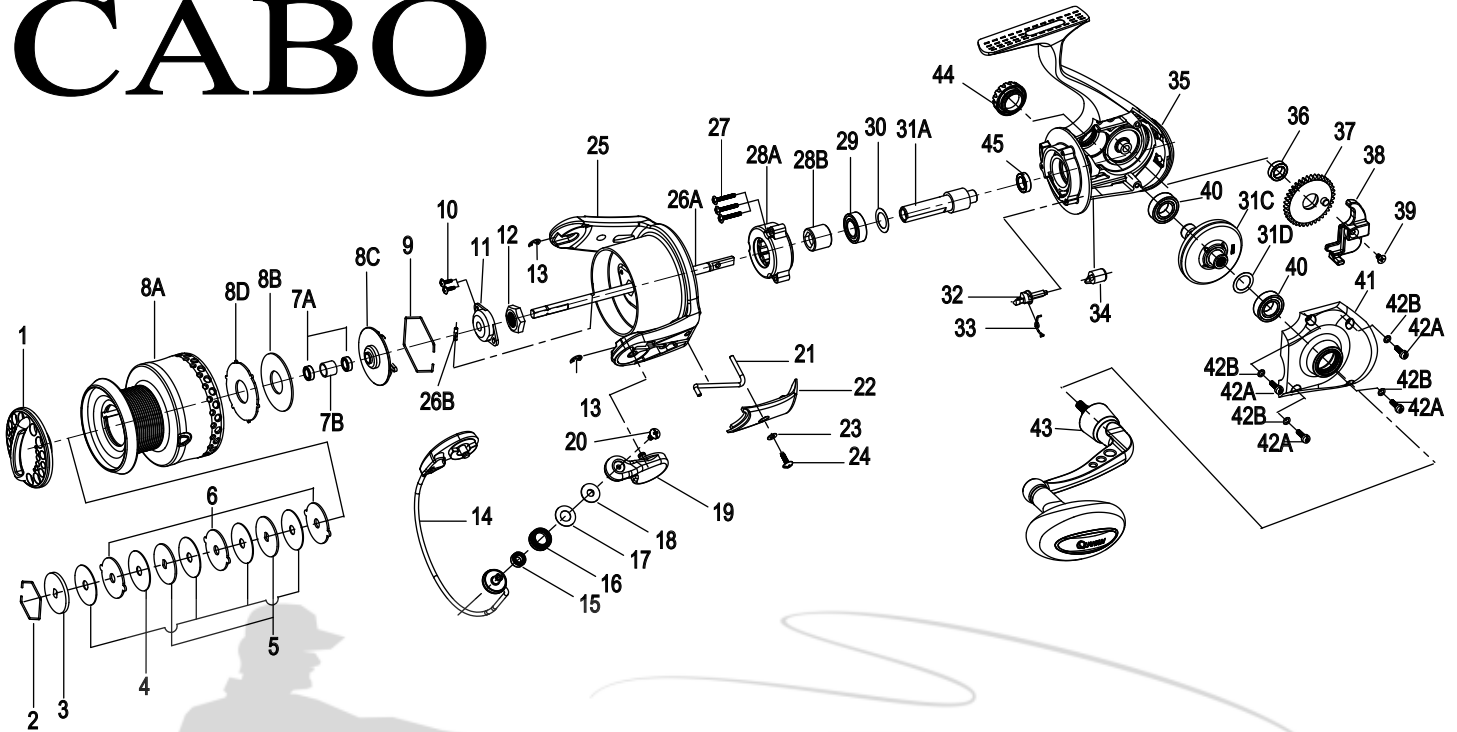

KEY #	DESCRIPTION	CABO 50	CABO 60
1	DRAG KNOB ASSEMBLY	BT332-51	BT332-51
2	SPOOL RETAINER - TOP	BT038-02	BT038-02
3	DRAG WASHER "D"	CT080-02	CT080-02
4	DRAG WASHER "B"	BT033-01	BT033-01
5	DRAG WASHER "D"	BT080-01	BT080-01
6	DRAG WASHER "A"	BT081-01	BT081-01
7	SPOOL BUSHING OR BEARING KIT	CT4157-01	CT4157-01
	7A - SPOOL BUSHING OR BEARING	QTY - 2	QTY - 2
	7B - SPOOL SPACER	QTY - 1	QTY - 1
8	SPOOL ASSEMBLY KIT	BT4321-51	CT4321-51
	8A - SPOOL ASSEMBLY	QTY - 1	QTY - 1
	2 - SPOOL RETAINER - TOP	QTY - 1	QTY - 1
	3 - DRAG WASHER "D"	QTY - 1	QTY - 1
	4 - DRAG WASHER "B"	QTY - 5	QTY - 5
	5 - DRAG WASHER "D"	QTY - 2	QTY - 2
	6 - DRAG WASHER "A"	QTY - 3	QTY - 3
	7 - SPOOL BUSHING OR BEARING KIT	QTY - 1	QTY - 1
	8B - SPOOL WASHER	QTY - 1	QTY - 1
	8C - DRAG CLICK ASSEMBLY	QTY - 1	QTY - 1
	8D - DRAG WASHER "E"	QTY - 1	QTY - 1
	9 - SPOOL RETAINER - BOTTOM	QTY - 1	QTY - 1
9	SPOOL RETAINER - BOTTOM	BT038-01	BT038-01
10	ROTOR NUT LOCK SCREW	RQ094-01	RQ094-01
11	MAIN SHAFT BUSHING	BT214-01	BT214-01
12	ROTOR NUT	BT006-01	BT006-01
13	E-CLIP - BAIL ASSEMBLY	GH034-01	GH034-01
14	BAIL ASSEMBLY	BT347-01	BT347-01
15	LINE ROLLER BEARING	GH202-01	GH202-01
16	LINE ROLLER	CH004-03	CH004-03
17	LINE ROLLER WASHER	DH102-01	DH102-01
18	LINE ROLLER COLLAR	CH102-01	CH102-01
19	ARM LEVER ASSEMBLY	BT307-02	BT307-02
20	SCREW - LINE SLIDER	AQ108-01	AQ108-01
21	KICK LEVER	BT019-01	BT019-01

KEY #	DESCRIPTION	CABO 50	CABO 60
22	ARM LEVER COVER	BT087-01	BT087-01
23	ARM LEVER COVER WASHER	SQ142-01	SQ142-01
24	A/L COVER SCREW	GU077-02	GU077-02
25	ROTOR ASSEMBLY	BT309-01	BT309-02
26	MAIN SHAFT KIT	BT4015-01	BT4015-01
	26A - MAIN SHAFT	QTY - 1	QTY - 1
	26B - MAIN SHAFT PIN	QTY - 1	QTY - 1
27	SCREW - CLUTCH	AT041-01	AT041-01
28	CLUTCH ASSEMBLY KIT	CT4360-01	CT4360-01
	28A - CLUTCH ASSEMBLY	QTY - 1	QTY - 1
	28B - CLUTCH SLEEVE	QTY - 1	QTY - 1
29	PINION BALL BEARING	BT157-01	BT157-01
30	PINION GEAR WASHER	BT110-01	BT110-01
31	GEAR KIT	BT4011-02	BT4011-02
	31A - PINION GEAR	QTY - 1	QTY - 1
	31B - PINION BUSHING	N/A	N/A
	31C - DRIVE GEAR ASSEMBLY	QTY - 1	QTY - 1
	31D - D.GEAR ADJUST WASHER	QTY - 1	QTY - 1
32	A/R CAM	BT090-01	BT090-01
33	A/R CAM SPRING	RQ089-01	RQ089-01
34	A/R LEVER	RQ059-01	RQ059-01
35	BODY ASSEMBLY	BT301-51	BT301-52
36	O/S GEAR BUSHING OR BEARING	CH027-01	CH027-01
37	O/S GEAR	BT053-01	BT053-01
38	O/S SLIDER	BT025-01	BT025-01
39	MAIN SHAFT SCREW	RQ100-01	RQ100-01
40	BODY BALL BEARING	BT157-01	BT157-01
41	BODY COVER	BT023-51	BT023-52
42	BODY COVER SCREW KIT	AT4057-02	AT4057-02
	42A - BODY COVER SCREW	QTY - 4	QTY - 4
	42B - SCRATCH PROTECT WASHER	QTY - 4	QTY - 4
43	HANDLE ASSY	BT318-52	BT318-52
44	HANDLE COVER - DUST CAP	BT073-51	BT073-51
45	PINION SMALL BALL BEARING	CH027-01	CH027-01