

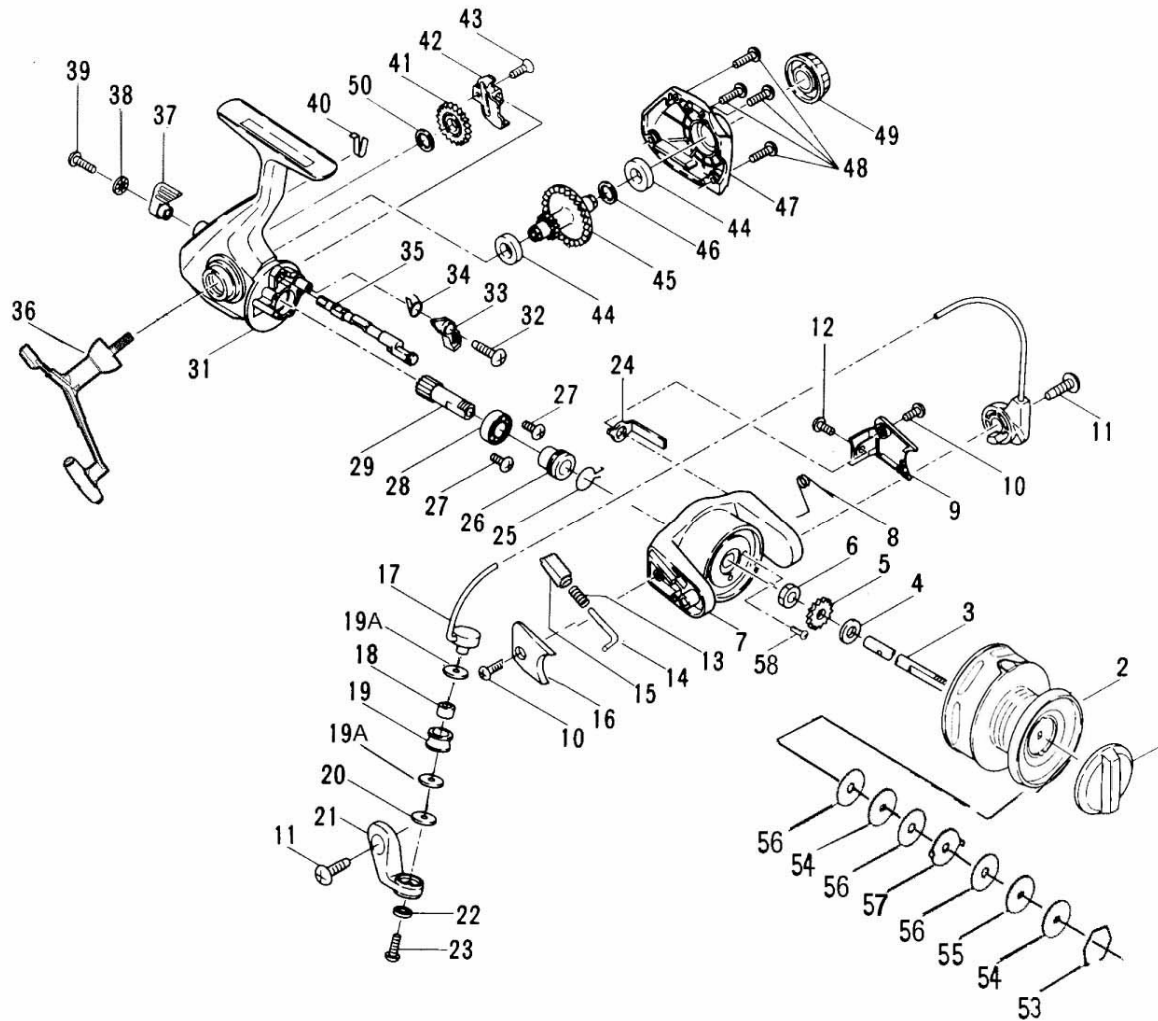

PARTS LIST FOR MODEL PG3-2000



KEY NO.	DESCRIPTION	PART NO.
1	Drag Knob Asm. w/Spring	052 1500
2	Spool Assembly	047 2000P
3	Spool Shaft	039 2000
4	Thrust Washer	060 1500
5	Click Ratchet	040B1500
6	Rotor Nut	038 1000
7	Rotor Cup	027 2000P
8	Cam Lever Spring	106 2000P
9	Cam Lever Cover	227 2000P
10	Cover Screws (2 req.)	050 1000
11	Arm Screws (2 req.)	031A1000
12	Cam Lever Mtg. Screw	028B1500
13	Pivot Spring	034C1500P
14	Pivot Shaft	034B1500P
15	Pivot Guide	034D1500P
16	Bail Pivot Cover	027A2000P
17	Bail Wire Assembly	024 2000P
18	Line Roller Bushing	035A1000
19	Line Roller	035 1000
19A	Line Roller Teflon Washer (2 req.)	035B1000P
20	Line Roller Washer	132 1000
21	Bail Arm	034 1500P
22	Lock Washer	036A103
23	Bail Stud Screw	036 1000
24	Cam Lever	028A2000P
25	Silent Dog Spring	230 1500
26	Pinion Spacer	019A1500
27	Bearing Mtg. Screws (2 req.)	023 1000
28	Ball Bearing	020 1000
29	Pinion Gear	019 1500
31	Housing	001 2000P
32	Dog Mounting Screw	003 1500
33	Anti-Reverse Dog	004 1500
34	Dog Spring	004A1500
35	Eccentric Shaft	006A1500
36	Handle Assembly	015 1000P
37	Eccentric Lever	006E1000
38	Lock Washer	006G1000
39	Ecc. Lever Mounting Screw	006F1000
40	Ecc. Shaft Spring	006D1000
41	Crosswind Gear	231 1500
42	Crosswind Block	043 1500
43	Crosswind Block Screw	044 1500
44	Cover & Housing Bearings (2 req.)	002B1500
45	Main Gear	008 1500P
46	Main Gear Shim	008A3000
47	Housing Cover	045 2000P
48	Cover Screws (4 req.)	046 1000
49	Bearing Cover	233 1000
50	Crosswind Gear Shim	231A1500
51**	Spool Click Tongue	048 1000P
51A**	Click Tongue Spring	049 103CS
52**	Click Tongue Screw	022 103CS
53	Drag Retaining Ring	051 1000
54	Keyed Drag Washer (2 req.)	057 1000
55	Thick Drag Washer (1 req.)	052A1000
56	Teflon Drag Washers (3 req.)	006 1000
57	Ear Drag Washer (1 req.)	058 1000
58	Rotor Nut Locking Screw	038A1000

**Not Shown