

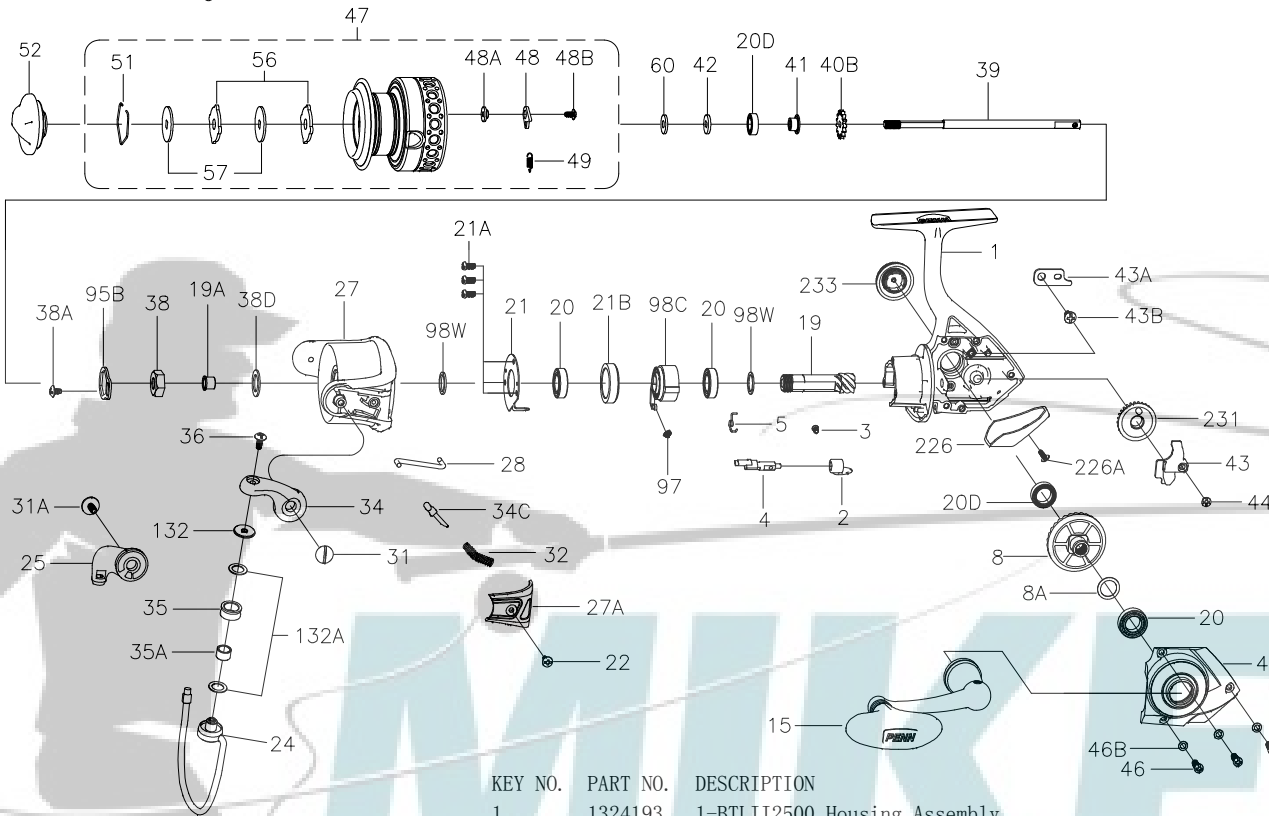

PARTS LIST FOR MODEL BTLII2500



KEY NO.	PART NO.	DESCRIPTION
25	1313810	25-CFT2500 Bail Holder
27	1324195	27-BTLII2500 Rotor
27A	1324196	27A-BTLII2500 Bail Pivot Cover
28	1324197	28-BTLII2500 Trip Lever
31	1324187	31-BTLII2000 Bail Arm Screw
31A	1324188	31A-BTLII2000 Bail Cam Screw
32	1191583	32-2000SG Bail Spring
34	1313815	34-CFT2500 Bail Arm
34C	1313816	34C-CFT2500 Pivot Arm
35	1324189	35-BTLII2000 Line Roller
35A	1313818	35A-CFT2500 Line Roller Bushing
36	1251748	36-1000FRC Bail Stud Screw
38	1191727	38-2000SG Rotor Nut
38A	1324171	38A-BTLII4000 Rotor Locking Plate Screw
38D	1308070	38D-CFT3000 Rotor Nut Washer
39	1313819	39-CFT2500 Main Shaft
40B	1191778	40B-2000SG Click Ratchet
41	1211573	41-2000BTL Spool Bushing
42	1249042	42-1000BTL Spool Shaft Washer
43	1313820	43-CFT2500 Crosswind Block
43A	1191818	43A-3000SG Crosswind Block Plate
43B	1191826	43B-3000SG Crosswind Block Plate Screw
44	1191843	44-3000SG Crosswind Block Screw
45	1324198	45-BTLII2500 Housing Cover Assembly
46	1191901	46-3000SG Housing Cover Screw (3 req)
46B	1191907	46B-3000SG Housing Cover Washer (3 req)
47	1324199	47-BTLII2500 Spool Assembly
48	1211604	48-3000SG Click Tongue
48A	1214226	48A-3000SG Click Tongue Washer
48B	1211591	48B-3000BTL Spool Click Screw
49	1211605	49-3000SG Click Tongue Spring
51	1313823	51-CFT2500 Drag Retaining Ring
52	1324192	52-BTLII2000 Drag Knob Assembly
56	1313825	56-CFT2500 Drag Washer (2 req)
57	1192041	57-2000SG Keyed Washer (2 req)
60	1192059	60-2000SG Thrust Washer
95B	1308081	95B-CFT3000 Rotor Locking Plate
97	1192189	97-2000SG Clutch Spring
98C	1192211	98C-2000SG Clutch/Sleeve Assembly
98W	1192229	98W-3000SG Upper Clutch Washer
98W	1204004	98W-3000PUR Lower Clutch Washer
132	1364008	132-BTLII2500 Roller Washer
132A	1192301	132A-2000SG Line Roller Washer (2 req)
226	1313827	226-CFT2500 Rear Cover
226A	1192473	226A-3000SG Rear Cover Screw
231	1313828	231-CFT2500 Crosswind Gear
233	1211608	233-3000BTL Bearing Cover Assembly

KEY NO.	PART NO.	DESCRIPTION
1	1324193	1-BTLII2500 Housing Assembly
2	1190889	2-2000SG A/R Lever
3	1190922	3-2000SG A/R Lever Screw
4	1313805	4-CFT2500 A/R Shaft
5	1313806	5-CFT2500 A/R Spring
8	1308047	8-CFT3000 Main Gear
8A	1191028	8A-3000SG Shim
15	1324182	15-BTLII2000 Handle Assembly
19	1364313	19-BTLII2500 Pinion Gear
19A	1364314	19A-BTLII2500 Pinion Bushing
20	1308050	20-CFT3000 Ball Bearing (3 req)
20D	1211610	20D-5000BTL Housing Ball Bearing
20D	1211567	20D-2000BTL Spool Ball Bearing
21	1192629	21-2000SG Bearing Retainer
21A	1192644	21A-3000SG Bearing Retainer Screw (3 req)
21B	1192646	21B-2000SG Collar
22	1192658	22-2000SG Bail Pivot Cover Screw
24	1324194	24-BTLII2500 Bail Wire

407-BTLII2500 Rev.1 7-25-14

1338217