

SPECIFICATIONS:

Year of Intro	1998
Thrust	36LBS
Volts	12VDC
Amp Draw	0 to 48 amps
Mount	01 Bow
Speeds	5 Forward

QUICK REFERENCE PARTS GUIDE:

Momentary switch	AP151-01
Toggle Switch	FP153-03
Motor Seal Kit	6220
Rotary Switch	HF150-01

PARTS ORDERING & TECH ASSISTANCE

MotorGuide Consumer Relations
 Phone 918-831-6989
 Fax 800-982-8093

Send Returned Goods to:

MotorGuide
 605 Hwy 12 West
 Starkville, MS 39760

Returned Goods must be accompanied with a Returned Goods Authorization. Contact MotorGuide Consumer Relations to obtain RGA.

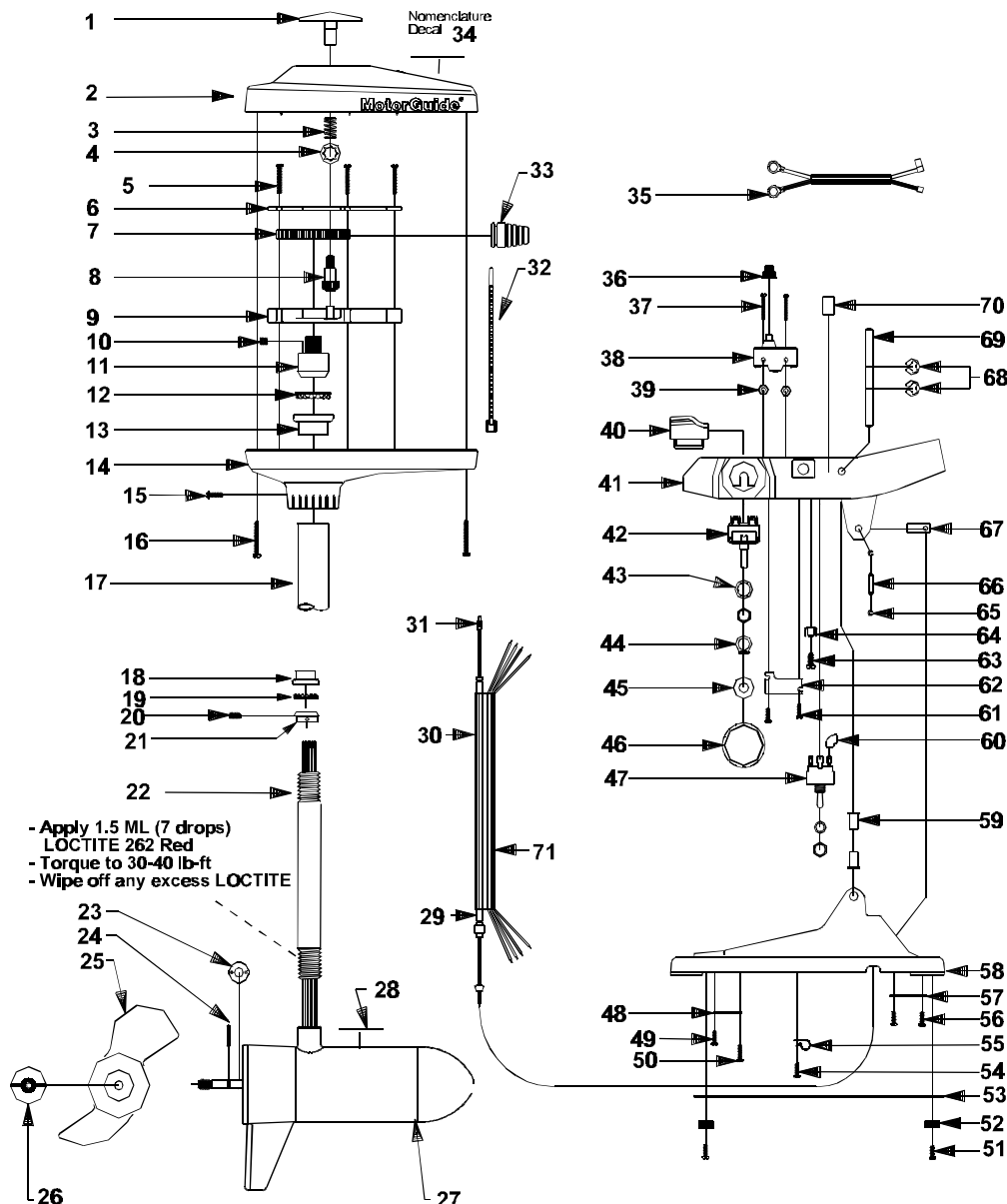

KEY	DESCRIPTION	PART #	KEY	DESCRIPTION	PART #	KEY	DESCRIPTION	PART #
1	INDICATOR BLACK	JF078-03	25	3 BLADE NINJA PROP	AF124-10	49	#6 SELF TAP SCREW	EK135-01
2	TOP HOUSING COVER BLACK	JF053-19	26	PROP NUT	AR099-01	50	6 X 1/2 SCREW	AF135-01
3	COMPRESSION SPRING	AF014-01	27	LOWER UNIT	PF397-01	51	6 X 1/2 SCREW	AF135-01
4	TINNERMAN CLIP	AF046-01	28	LOWER UNIT DECAL	ET060-04	52	FOOT PEDAL PAD	KP023-01
5	#6 RACK GUIDE SCREW	AF133-01	29	63" CONTROL CABLE STUD SUB ASY	9377	53	WEIGHT PLATE ASY	LP3123-01
6	RACK GUIDE COVER	AF127-01	30	69" CONTROL CABLE STUD ASY	9767	54	6 X 1/2 SCREW	AF135-01
7	RACK	AP125-01	31	69" 5 SP CONTROL CABLE ASY	LP327-06	55	CABLE CLAMP	KP036-01
8	INDICATOR GEAR	AF069-01	32	CONTROL CABLE STUD	LP327-08	56	SCREWS	IR133-01
9	RACK GUIDE	AF126-01	33	CABLE TIE	AP141-01	57	BATTERY CLAMP	KP036-02
10	1/4 NUT SET SCREW	AF142-01	34	NOMENCLATURE	AF030-01	58	FOOT PEDAL BASE	LP003-01
11	NUT-SUB ASY	AF398-02	35	BATTERY CABLE ASY	AP071-01	59	SHAFT BUSHING	KP021-01
12	BALL BEARING	AF005-01	36	MICRO SWITCH BOOT	FF056-12	60	INSULATING SLEEVE	AT080-01
13	BEARING CUP	AF007-01	37	#6 32 X 1 1/2 SCREW	LP135-01	61	6 X 1/2 SCREW	AF135-01
14	TOP HOUSING BASE F/O BLACK	JF004-03	38	MICRO SWITCH	AP151-01	62	RETAINER PLATE	LP123-03
15	6 X 5/8 SCREW	AP133-01	39	6 - 32 NUT S.S	SP098-02	63	#10 X 1/2" SCREW	GR133-01
16	8 X 1-3/8 SCREW	AR133-01	40	MICRO BUTTON	LP026-01	64	TERMINAL (4PRONG)	FT160-03
17	36" OUTER TUBE	AF165-01	41	FOOT PEDAL	LP101-03	65	E RING	FP046-01
18	42/50" OUTER TUBE	AF165-06	42	ROTARY SWITCH	HF150-01	66	CABLE PIVOT PIN	AP105-01
19	BEARING CUP	FM007-01	43	LOCK WASHER 3/8	KP171-01	67	CABLE PIVOT	LP091-01
20	BALL BEARING	FM005-01	44	GRIP RING	LP046-01	68	E RING	BK046-01
21	SET SCREW	AF143-01	45	NYLON WASHER	AK171-02	69	FOOT PEDAL ROCKER PIN	LP102-01
22	36" .187 ALUM. F/O COLUMN	DF049-01	46	5 SPEED KNOB	LP082-07	70	CON/MOM/HBP SWITCH DECAL	LP057-03
23	42" .187 ALUM. F/O COLUMN	DF049-02	47	TOGGLE SWITCH 3 POSITIONS	FP153-03	71	63" ELECTRIC CABLE JACKET	MM9006-02
24	PROP DRIVE PIN	BR102-01	48	CABLE PLATE	KP123-01		69" ELECTRIC CABLE JACKET	MM9006-03

LOWER UNIT BREAKDOWN

Model:
F36

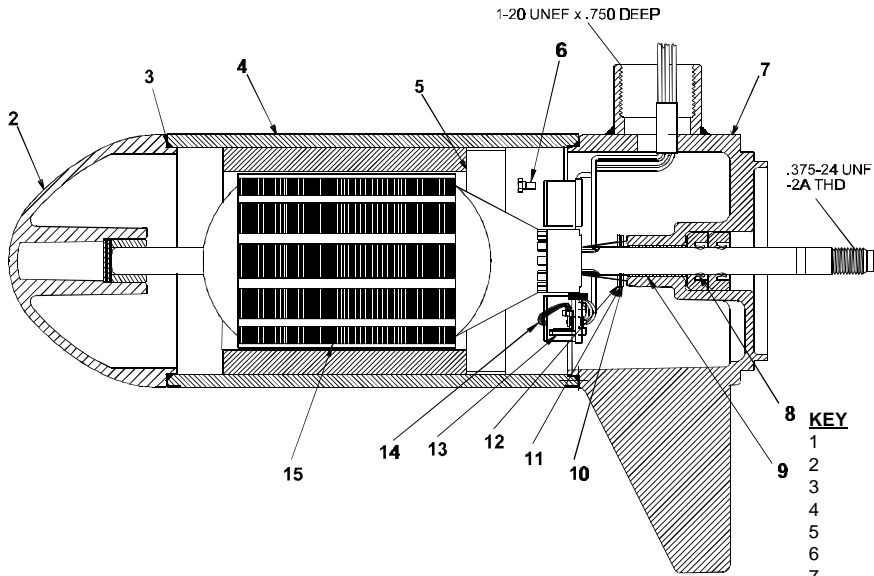

NOTE: TORQUE THRU BOLTS TO 40 TO 50 INCH LBS.

KEY	QTY	DESCRIPTION	PART NO.
1	X	MOTOR	PF397-01
2	1	NOSE CAP	JF3212-01
3	2	O RING SEAL	MR217-01
4	1	HOUSING ASY	PF3210-01
5	1	RETAINER	JF233-01
6	2	BRUSH CARD SCREW	MR228-01
7	1	COMM CAP	ET3205-01
8	2	SHAFT SEAL	MR223-01
9	1	BEARING	MR206-01
10	1	NYLATRON WASHER	MR226-01
11	1	WASHER	MR227-01
12	1	E RING	MR219-02
13	2	BRUSH SPRINGS	MR214-02
14	1	BRUSH ASY LESS SPRING	DF3201-01
15	1	ARMATURE 3.5"	PF3207-01
16	4	STATIC SEAL	MR222-01
17	4	THRU BOLT WASHER	MR216-01
18	2	THRU BOLT	MR218-14

WIRING

12V WIRING DIAGRAM

