

# SWEEPFIRES 2550R

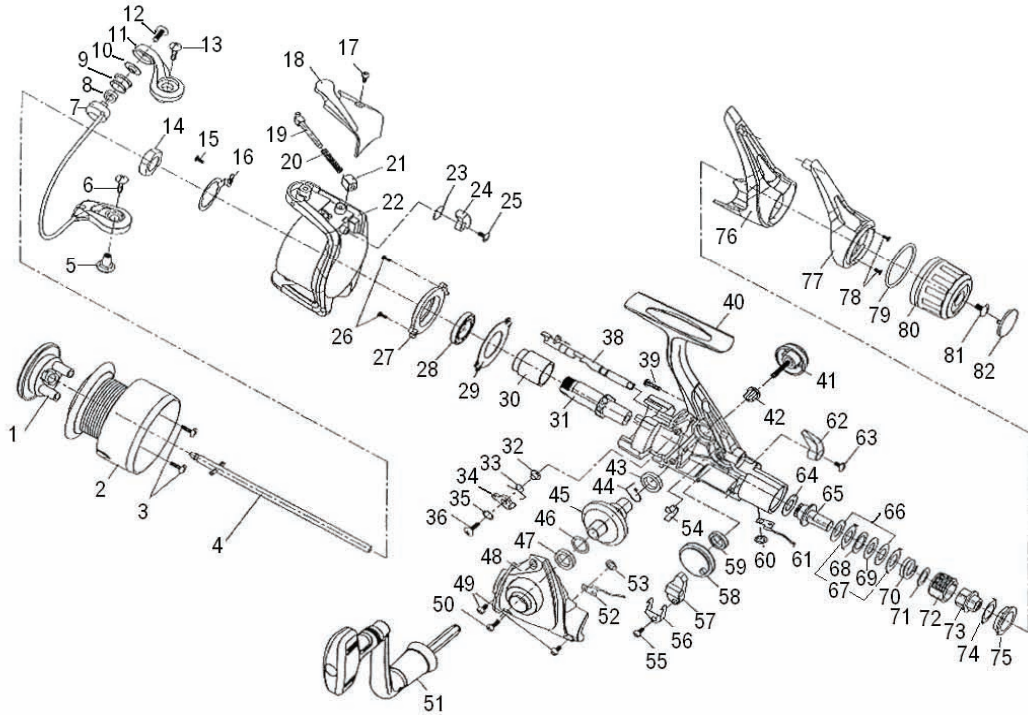

Key No.	Parts No.	Parts Name	Key No.	Parts No.	Parts Name
1	W56-0001	FRONT DRAG KNOB	42	W34-4701	HANDLE COLLAR
1-3	W56-0101	SPOOL	43, 47	W34-5301	DRIVE GEAR BUSHING
4	W38-0301	MAIN SHAFT	44	W34-3901	A/R PAWL SPRING B
5	W34-0201	BAIL HOLDER NUT	45	W46-0401	DRIVE GEAR
6	W38-0201	BAIL HOLDER SCREW	46	W34-3701	DRIVE GEAR WASHER
7	W33-7901	BAIL	48	W56-0401	SIDE COVER
8	W38-0551	LINE ROLLER BUSHING	49	W38-5301	SIDE COVER SCREW A
9	W33-8101	LINE ROLLER	50	W45-8301	SIDE COVER SCREW B
10	W33-8201	LINE ROLLER COLLAR	51	W51-7501	HANDLE
11	W51-3702	BAIL ARM	52	W38-5101	CLICK LEAF SPRING A
12	W38-0901	LINE ROLLER SCREW	53, 60	W38-5001	CLICK LEAF SPRING RET
13	W33-8401	BAIL ARM SCREW	54	W44-1101	A/R CAM SPRING
14	W38-1101	ROTOR NUT	55	W38-5501	OSC SLIDER SCREW
15	W33-9101	ROTOR NUT HOLD PLT SCREW	56	W38-5601	OSC SLIDER RET
16	W33-9501	ROTOR NUT HOLD PLT	57	W38-5701	OSC SLIDER
17	W38-1901	BAIL SPRING COVER SCREW	58	W34-2701	OSC GEAR
18	W51-7301	BAIL SPRING COVER	59	W45-8701	OSC GEAR COLLAR
19	W33-8701	BAIL SPRING SHAFT	61	W38-5901	CLICK LEAF SPRING B
20	W33-8801	BAIL SPRING	62	W46-1901	A/R LEVER
21	W33-8901	BAIL SPRING HOLDER	63	W38-6101	A/R LEVER SCREW
22	W56-0201	ROTOR	64	W45-8801	DRAG METAL WASHER
23	W34-0501	BAIL TRIP LEVER SPRING	65	W45-8901	DRAG METAL A
24	W34-0601	BAIL TRIP LEVER	66	W45-9001	DRAG WASHER B
25	W38-2801	BAIL TRIP LEVER SCREW	67	W38-6501	EARED WASHER
26	W45-7401	BEARING RET SCREW	68	W38-6601	DRAG WASHER A
27	W34-0901	BEARING RET A	69	W38-6701	KEY WASHER
28	W34-1701	BALL BEARING	70	W38-6801	DRAG COIL SPRING
29	W34-1101	BEARING RET B	71	W45-9101	DRAG COIL SPRING WASHER
30	W34-1201	COLLAR	72	W38-7001	DRAG SCREW
31	W46-8901	PINION GEAR	73	W38-7101	DRAG METAL B
32	W45-7601	A/R PAWL COLLAR A	74	W38-7201	DRAG COLLAR
33	W45-7701	A/R PAWL SPRING A	75	W45-9201	DRAG COVER
34	W45-7801	A/R PAWL	76	W47-2201	REAR COVER A
35	W34-4101	A/R PAWL COLLAR B	77	W46-0801	REAR COVER B
36	W34-4301	A/R PAWL SCREW	78	W45-9501	REAR COVER B SCREW
38	W34-2001	A/R CAM	79	W38-7701	O RING
39	W38-4201	REAR COVER A SCREW	80	W46-2201	DRAG KNOB
40	W56-0301	BODY	81	W38-7901	DRAG KNOB SCREW
41	W48-4501	HANDLE LOCK SCREW	82	W46-2301	DRAG KNOB SCREW CAP