

CONVENTIONAL LEVER-DRAW OCEAN REEL **SEALINE** **TOURNAMENT** **SLT 50/SLT 50W**

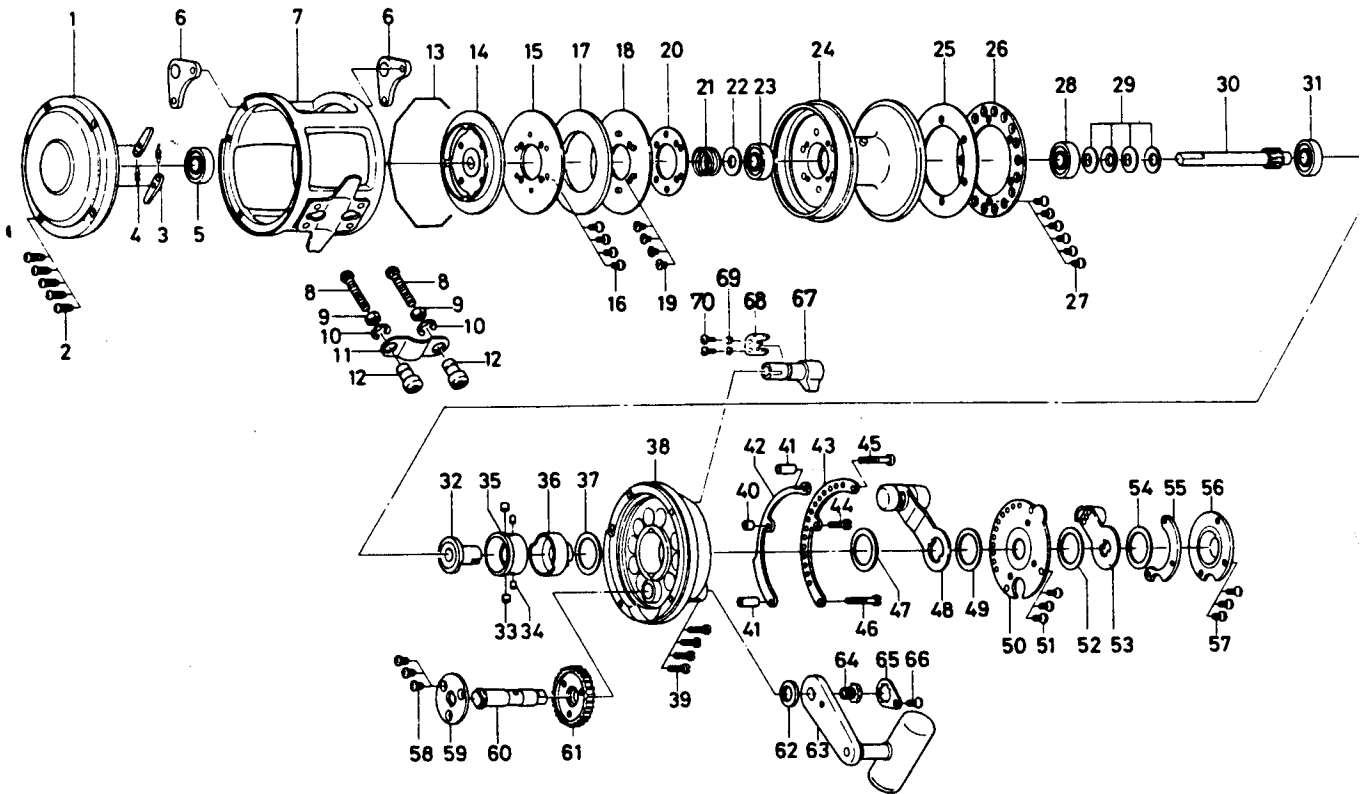

Key No.	Part No.	Parts Name
1	B89-0301	Left side plate
2	B83-1501	Left side plate screw
3	B70-4401	Anti-reverse pawl
4	144-8701	Anti-reverse pawl spring
5	B88-7801	Ball bearing
6	B88-5201	Harness lug
7	B88-8901	Frame
8	364-1101	Clamp bolt
9	B11-0902	Clamp nut
10	321-1101	Clamp retainer
11	B89-0601	Rod brace
12	342-5301	Rod brace nut
13	B89-0201	Spool retainer
14	B70-3702	Ratchet plate
15	B89-0001	Metal drag washer A
16	B70-3401	Metal drag washer screw A
17	B89-0101	Drag washer
18	B88-9901	Metal drag washer B
19	B00-4301	Metal drag washer screw B
20	B83-2701	Spool plate
21	B83-2901	Ball bearing spring
22	375-0503	Ball bearing washer
23	B88-7801	Ball bearing
24	B88-9701	Spool
25	B88-6101	Click plate A
26	B88-6002	Click plate B
27	B70-3401	Click plate screw
28	B88-7801	Ball bearing
29	B88-8601	Disc spring washer
30	B88-9501	Pinion gear
31	B88-7801	Ball bearing
32	B88-7701	Eccentric cam A
33	B83-1301	Eccentric cam pin A
34	B69-8701	Eccentric cam pin B
35	B88-7601	Sleeve
36	B88-7501	Eccentric cam B
37	B89-5502	Eccentric cam washer
38	B88-7101	Right side plate

Key No.	Part No.	Parts Name
39	B83-1501	Right side plate screw
40	B88-5301	Quadrant ring collar (short)
41	B70-2501	Quadrant ring collar (long)
42	B88-9401	Quadrant ring A
43	B88-9302	Quadrant ring B
44	B99-8201	Quadrant ring screw A
45	B83-2401	Quadrant ring screw B
46	B83-2501	Quadrant ring screw C
47	B89-5502	Drag lever washer A
48	B92-1901	Drag lever A
49	B89-5502	Drag lever washer B
50	B88-8101	Pre-set plate
51	353-1201	Bridge cover screw
52	B89-5502	Drag lever washer C
53	B92-2001	Drag lever B
54	B89-5502	Drag lever washer D
55	B88-3501	Lever support plate
56	B88-3601	Cover plate
57	353-1201	Cover plate screw
58	B70-3401	Drive gear plate screw
59	B88-4001	Drive gear plate
60	B88-3901	Drive shaft
61	B88-8301	Drive gear
62	B88-4101	Drive shaft washer
63	B88-8401	Handle
64	B88-4501	Handle screw
65	B88-4701	Handle plate
66	353-1201	Handle plate screw
67	E05-9101	Click lever
68	E05-8801	Click lever retainer
69	160-8401	Click lever retainer washer
70	351-6407	Click lever retainer screw

SLT 50W Special Parts

1	B89-8901	Left side plate
7	B89-6301	Frame
24	B89-6701	Spool
30	B89-6601	Pinion gear