

CROSSFIRE 1550-3iR

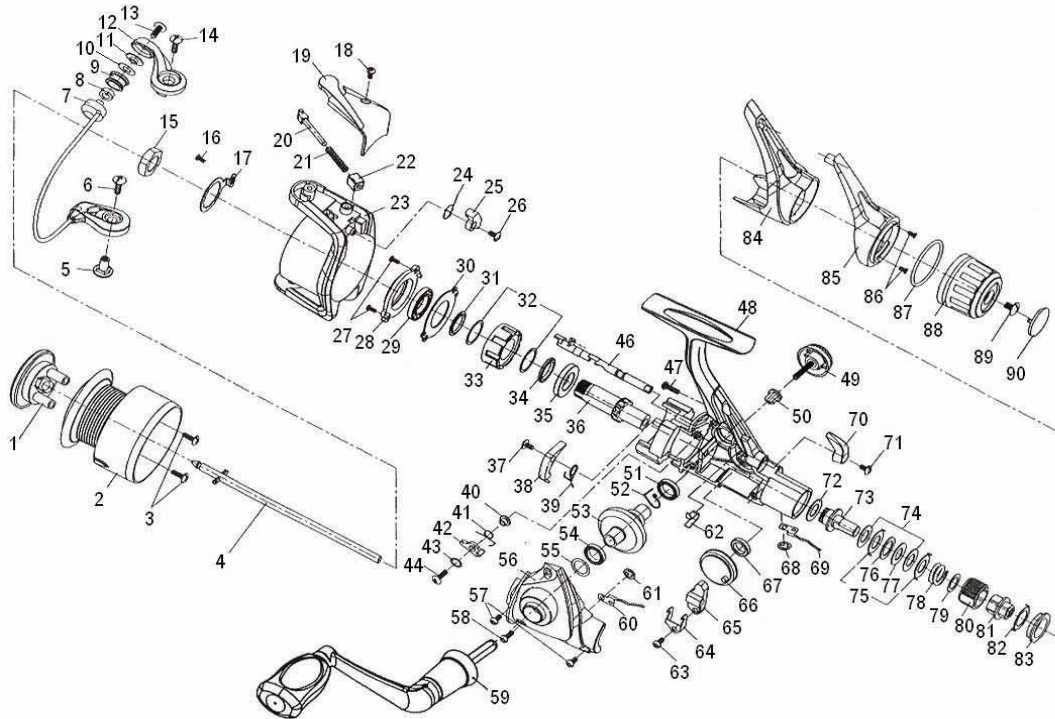

Key No.	Parts No.	Parts Name	Key No.	Parts No.	Parts Name
1	W45-9701	FRONT DRAG KNOB	47	W38-4201	REAR COVER A SCREW
1-3	W55-7801	SPOOL	48	W55-8101	BODY
1-3	W55-7901	SPOOL (EXTRA)	49	W44-0701	HANDLE SCREW
4	W45-6301	MAIN SHAFT	50	W34-4701	HANDLE COLLAR
5	W34-0201	BAIL HOLDER NUT	51	W34-3601	BALL BEARING B
6	W45-6401	BAIL HOLDER SCREW	52	W34-3901	A/R PAWL SPRING C
7	W43-9501	BAIL	53	W34-3801	DRIVE GEAR
8	W38-0551	LINE ROLLER BUSHING	54	W34-3601	BALL BEARING C
9	W33-8101	LINE ROLLER	55	W36-3701	DRIVE GEAR COLLAR
10	W45-6601	LINE ROLLER WASHER	56	W55-8201	SIDE COVER
11	W33-8201	LINE ROLLER COLLAR	57	W38-5301	SIDE COVER SCREW A
12	W51-3701	BAIL ARM	58	W45-8301	SIDE COVER SCREW B
13	W38-0901	LINE ROLLER SCREW	59	W51-4401	HANDLE
14	W33-8401	BAIL ARM SCREW	60	W38-5101	CLICK LEAF SPRING A
15	W38-1101	ROTOR NUT	61, 68	W38-5001	CLICK LEAF SPRING RET
16	W33-9101	ROTOR NUT HOLD PLT SCREW	62	W44-1101	A/R CAM SPRING
17	W33-9501	ROTOR NUT HOLD PLT	63	W38-5501	OSC SLIDER SCREW
18	W45-7001	BAIL SPRING COVER SCREW	64	W38-5601	OSC SLIDER RET
19	W34-0301	BAIL SPRING COVER	65	W45-8501	OSC SLIDER
20	W45-7101	BAIL SPRING SHAFT	66	W45-8601	OSC GEAR
21	W45-7201	BAIL SPRING	67	W45-8701	OSC GEAR COLLAR
22	W33-8901	BAIL SPRING HOLDER	69	W38-5901	CLICK LEAF SPRING B
23	W55-8001	ROTOR	70	W34-2401	A/R LEVER
24	W34-0501	BAIL TRIP LEVER SPRING	71	W38-6101	A/R LEVER SCREW
25	W34-0601	BAIL TRIP LEVER	72	W45-8801	DRAG METAL WASHER
26	W38-2801	BAIL TRIP LEVER SCREW	73	W45-8901	DRAG METAL A
27	W45-7401	BEARING RET A SCREW	74	W45-9001	DRAG WASHER A
28	W34-0901	BEARING RET A	75	W38-6501	EARED WASHER
29	W34-1701	BALL BEARING A	76	W38-6601	DRAG WASHER B
30	W34-1101	BEARING RET B	77	W38-6701	KEY WASHER
31	W34-1201	BEARING RET WASHER	78	W38-6801	DRAG COIL SPRING
33	W34-1401	ROLLER CLUTCH	79	W45-9101	DRAG COIL SPRING WASHER
34	W45-7501	ROLLER CLUTCH COLLAR	80	W38-7001	DRAG SCREW
35	W46-1401	PINION GEAR COLLAR	81	W38-7101	DRAG METAL B
36	W46-8901	PINION GEAR	82	W38-7201	DRAG COLLAR
37	W38-3801	A/R PAWL SCREW	83	W45-9201	DRAG COVER
38	W34-4501	A/R PAWL A	84	W46-2001	REAR COVER A
39	W34-4401	A/R PAWL SPRING A	85	W47-3101	REAR COVER B
40	W45-7601	A/R PAWL COLLAR	86	W59-5010	REAR COVER B SCREW
41	W45-7701	A/R PAWL SPRING B	87	W38-7701	O RING
42	W45-7801	A/R PAWL B	88	W45-9601	DRAG KNOB
43	W34-4101	A/R PAWL COLLAR	89	W38-7901	DRAG KNOB SCREW
44	W34-4301	A/R PAWL SCREW	90	W38-8001	DRAG KNOB SCREW CAP
46	W45-7901	A/R CAM			