

SPINNING REEL AG 1350A

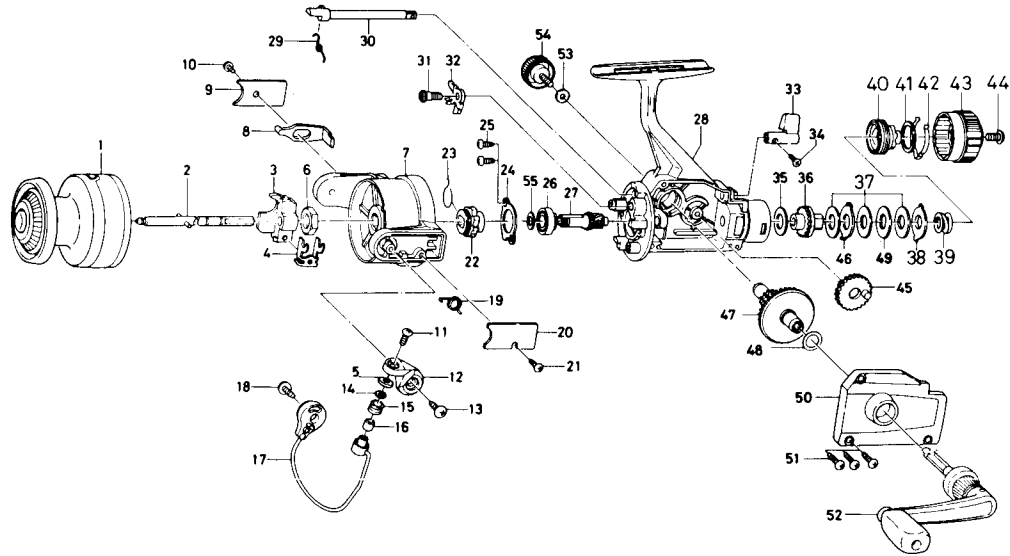

Key No.	Parts No.	Parts Name	Key No.	Parts No.	Parts Name
1	K10-6401	Spool	29	B44-8501	Anti-reverse cam spring
2	K02-4901	Main shaft	30	B44-8401	Anti-reverse cam
3	B97-9601	Oscillating slider	31	K03-2801	Anti-reverse pawl screw
4	K02-5101	Oscillating slider retainer	32	K02-2701	Anti-reverse pawl
5	B97-9801	Liner roller washer A	33	E08-3702	Anti-reverse lever
6	B67-9401	Rotor nut	34	B12-8201	Anti-reverse lever screw
7	B81-8601	Rotor	35	B48-9902	Drag washer A
8	B83-5701	Bail trip lever	36	B83-3602	Click gear
9	B74-7301	Bail trip cover	37	B49-0202	Drag washer B
10	B83-4402	Bail trip cover screw	38	B49-0102	Eared washer A
11	B67-9302	Line roller screw	39	B92-6703	Drag coil spring
12	B68-1102	Bail arm	40	B74-7603	Drag screw
13	B84-2102	Bail arm screw	41	B90-8201	Drag washer C
14	B55-4301	Line roller washer B	42	B74-7702	Drag washer spring
15	250-3921	Line roller	43	K04-8603	Drag knob
16	B45-1501	Line roller bushing	44	352-1105	Drag knob spring screw
17	K10-6702	Bail	45	B74-2501	Oscillating gear
18	B84-2102	Bail trip cam screw	46	B63-8301	Eared washer B
19	K04-9801	Bail spring	47	E08-9701	Drive gear
20	B45-0901	Bail spring cover	48	373-7800	Drive gear washer
21	B83-4402	Bail spring cover screw	49	849-0301	Key washer
22	K02-2801	Anti-reverse ratchet	50	K10-6201	Side cover
23	K02-5401	Anti-reverse pawl spring	51	B83-5002	Side cover screw
24	B45-6401	Bearing retainer	52	E00-1603	Handle
25	B83-4402	Bearing retainer screw	53	B92-4902	Handle lock washer
26	E04-0401	Bushing	54	B92-5001	Handle lock screw
27	E08-9501	Pinion gear	55	E09-0701	Bushing washer
28	K05-2504	Body			